



EverFlo
EverFlo Q













USER MANUAL







EverFlo / EverFlo Q User Manual

TABLE OF CONTENTS

Symbols Glossary	2
Abbreviations	3
Classifications	3
How to Contact Philips Respirationics	4
Chapter 1: Introduction.....	4
Chapter 2: Operating Instructions.....	8
Chapter 3: Cleaning, Disinfecting, and Maintenance.....	10
Chapter 4: Alarms and Troubleshooting	11
Chapter 5: Specifications	14
Appendix A: EMC Information	17
Limited Warranty	19

Symbols Glossary

Symbol	Title and Meaning
	Refer to the instruction manual To signify that the instruction manual must be read.
	Type BF applied part To identify a type BF applied part complying with IEC 60601-1.
	Class II equipment (Double Insulated) To identify equipment meeting the safety requirements specified for Class II equipment.
	No smoking To prohibit smoking.
	No open flame To prohibit smoking and all forms of open flame.
	No oil or grease
	Do not disassemble
	Alarm Indicates an alarm condition.
	AC power (Alternating current) Indicates on the rating plate that the equipment is suitable for alternating current only; to identify relevant terminals.
	Catalogue number Indicates the manufacturer's catalogue number so the medical device can be identified.
	Serial number Identifies the manufacturer's serial number for the medical device.
	On (Power) Indicates connection to the mains.
	Off Indicates disconnection from the mains.
IP21	Drip proof equipment

Symbol	Title and Meaning
	<p>Malfunction, general, failure Indicates that a failure or other malfunction has occurred.</p>
	<p>Compliant with the Waste Electrical and Electronic Equipment/Restriction of the Use of Certain Hazardous Substances in Electrical and Electronic Equipment (WEEE/RoHS) recycling directives</p>
	<p>Temperature Limit Indicates the temperature limits to which the medical device can be safely exposed.</p>
	<p>Humidity Limitation Indicates the range of humidity to which the medical device can be safely exposed.</p>
	<p>Atmospheric Pressure Limitation Indicates the acceptable upper and lower limits of atmospheric pressure.</p>
	<p>Manufacturer</p>
	<p>Authorized Representative in the European Community Indicates the Authorized Representative in the European Community.</p>

Abbreviations

LED	Light Emitting Diode
LPM	Liters per Minute
OPI	Oxygen Percentage Indicator

Classifications

- The EverFlo / EverFlo Q Oxygen Concentrator is classified as:
- IEC Class II Internally Powered Equipment
 - Type BF Applied Part
 - IP21 Drip Proof Equipment
 - Not suitable for use in the presence of a flammable anesthetic mixture with air or with oxygen or nitrous oxide.
 - Continuous Operation

How to Contact Philips Respironics

To have your device serviced, contact your equipment provider. If you need to contact Philips Respironics directly, call the Customer Service department at 1-724-387-4000 or +49 8152 93060. You can also use one of the following addresses:

Respironics Inc.
1001 Murry Ridge Lane
Murrysville, PA 15668 USA



Respironics Deutschland GmbH & Co. KG
Gewerbestrasse 17
82211 Herrsching, Germany



Chapter 1: Introduction

Your health care professional has determined that supplemental oxygen is of benefit to you and has prescribed an oxygen concentrator set at a specific flow setting to meet your needs. **DO NOT** change the flow settings unless your health care professional tells you to do so. Please read and understand this entire manual before using the device.

Intended Use

The EverFlo / EverFlo Q Oxygen Concentrator is intended to provide supplemental oxygen to persons requiring oxygen therapy. The device is not intended to be life supporting or life sustaining.

The device is for use in the home or hospital/institutional environment.

About Your EverFlo / EverFlo Q

The device produces concentrated oxygen from room air for delivery to a patient requiring low flow oxygen therapy. The oxygen from the air is concentrated using a molecular sieve and a pressure swing adsorption process. Your home care provider will show you how to operate the concentrator and will be available to answer any questions. If you have additional questions or problems, contact your home care provider.

Parts of Your Concentrator

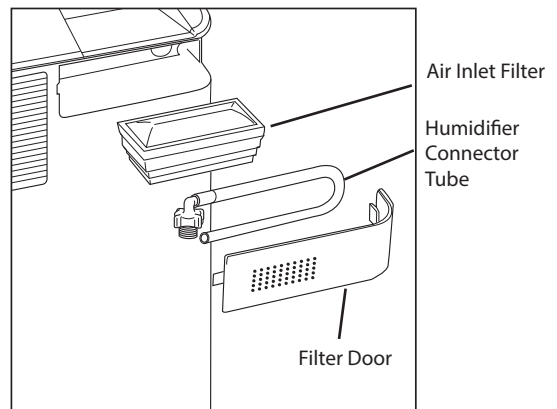
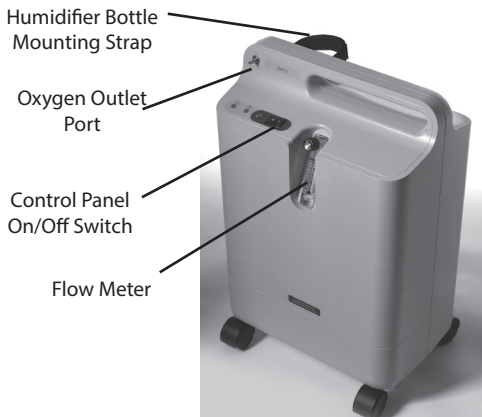

EverFlo models that are compatible with the UltraFill Oxygen Filling Station will include an additional connection port for connection to the UltraFill Oxygen Filling Station. The performance of the EverFlo is not affected when the port is connected to the UltraFill Oxygen Filling Station. The port is for connection to the UltraFill Oxygen Filling Station only, not for connecting the patient oxygen cannula. The patient oxygen cannula is connected to the EverFlo as shown later in this manual.

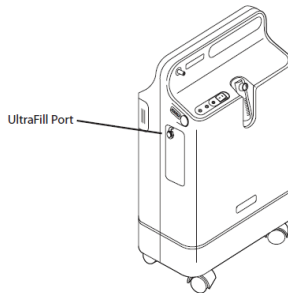

When the EverFlo is connected to the UltraFill Oxygen Filling Station, the maximum flow of the device that can be delivered to the patient will be reduced from 5 LPM to 3 LPM.

Note: When connected to the UltraFill Oxygen Filling Station, the EverFlo device disables its no flow and high flow alarms when a cylinder is in the process of being filled. If you are breathing from the EverFlo at this time and an occlusion occurs in the cannula, the EverFlo will not sense the disruption of the flow of oxygen to you. If you are breathing from the EverFlo device while filling a cylinder, ensure that you place your oxygen cannula in a position to avoid it being kinked or crushed. Refer to the Troubleshooting Guide for more information.

Accessory Equipment and Replacement Parts

Contact your home care provider if you have questions about this equipment. Use only the following Philips Respironics accessories and replacement parts with this device:

- Air Inlet Filter
- Humidifier Connector Tube
- The EverFlo device is compatible with all bottle style humidifiers supplied through Philips Respironics.

Accessories provided with the concentrator are to be specified for use at oxygen flows of 1 to 5 liters per minute and a maximum pressure of 6.5 PSIG (44.8 kPa). In addition, cannulas must be a minimum of 2.13 meters (7 feet) in length and a maximum of 45.7 meters (150 feet).

The organization that provides this equipment to the patient for use is accountable for ensuring the compatibility of the accessories used to connect the patient to the oxygen concentrator to the requirements of ISO 80601-2-69. In order to meet the requirements of ISO 80601-2-69, the accessory cannula must have a fire stop device that stops fire and flow of oxygen to the patient.

Contact your home care provider if you have any questions concerning the use of accessories.

WARNING: The use of incompatible parts or accessories can result in degraded performance.

Warnings and Cautions

Warnings

A warning represents the possibility of harm to the operator or patient.

- For proper operation, your concentrator requires unobstructed ventilation. The ventilation ports are located at the rear base of the device and at the side air inlet filter. Keep the device at least 15 to 30 cm away from walls, furniture, and especially curtains that could impede adequate airflow to the device. Do not place the concentrator in a small closed space (such as a closet). The device should not be used adjacent to or stacked with other equipment. For more information, contact your home care provider.
- Do not remove the covers of this device. Servicing must be referred to an authorized and trained Philips Respironics home care provider.
- In the event of an equipment alarm or if you are experiencing any signs of discomfort consult your home care provider and/or your health care professional immediately.
- Oxygen generated by this concentrator is supplemental and should not be considered life supporting or life sustaining. In certain circumstances oxygen therapy can be hazardous; any user should seek medical advice prior to using this device.
- Where the prescribing health care professional has determined that an interruption in the supply of oxygen, for any reason, may have serious consequences to the user, an alternate source of oxygen should be available for immediate use.
- Oxygen vigorously accelerates combustion and should be kept away from heat or open flame. Not suitable for use in the presence of a flammable anesthetic mixture with air or with oxygen or nitrous oxide.
- Oxygen makes it easier for a fire to start and spread. Do not leave the nasal cannula or mask on bed coverings or chair cushions, if the oxygen concentrator is turned on, but not in use; the oxygen will make the materials flammable. Turn the oxygen concentrator off when not in use to prevent oxygen enrichment.
- Accessories used to connect the patient to the oxygen concentrator must be compatible to the requirements of ISO 80601-2-69. Application accessories shall include a means to reduce the propagation of fire, including having a fire stop device that stops fire and flow of oxygen to the patient.
- Do not smoke, allow others to smoke, or have open flames near the concentrator when it is in use. Smoking during oxygen therapy is dangerous and is likely to result in facial burns or death.
- Do not use oil or grease on the concentrator or its components as these substances, when combined with oxygen, can greatly increase the potential for a fire hazard and personal injury.
- Do not use the oxygen concentrator if either the plug or power cord is damaged. Do not use extension cords or electrical adapters.
- Do not attempt to clean the concentrator while it is plugged into an electrical outlet.
- Device operation above or outside of the voltage, LPM, temperature, humidity and/or altitude values specified may decrease oxygen concentration levels.
- Your home care provider is responsible for performing appropriate preventive maintenance at the intervals recommended by the device manufacturer.
- Portable and mobile RF communications equipment can affect Medical Electrical Equipment. See the EMC section of this manual for distances to observe between RF communications equipment and the device to avoid interference.
- Medical Electrical Equipment needs special precautions regarding EMC and needs to be installed and put into service according to the EMC information provided in this manual.

- The EverFlo is designed to meet current electromagnetic compatibility requirements. However, if you suspect operation of this device is interfered by or interferes with the normal operation of other electronic devices (such as TV, radio or other household appliances), try relocating the appliance or the device until the interference stops, or plugging the device into a different power outlet controlled by a separate circuit breaker or fuse.
- Be aware that the electrical cord and/or tubing could present a tripping or strangulation hazard.
- The No-Flow alarm is disabled when the low-flow meter is installed.
- Do not modify this system or equipment in any way. Modifications could result in hazards to the user.
- Place the device in a location so as to avoid pollutants and fumes.
- The oxygen delivery settings of the oxygen concentrator should be periodically reassessed for the effectiveness of the therapy.
- If you feel discomfort or are experiencing a medical emergency while undergoing oxygen therapy, seek medical assistance immediately to avoid harm.
- To ensure that you receive the correct therapeutic amount of oxygen delivery according to your medical condition, the Philips Respironics EverFlo device must be used:
 - Only after one or more settings have been individually determined or prescribed for you at your specific activity levels
 - With the specific combination of parts and accessories that are in line with the specification of the oxygen concentrator manufacturer and that were used while your settings were determined
- Use only water-based lotions or salves that are oxygen compatible during setup or use during oxygen therapy. To avoid the risk of fire and burns, never use petroleum or oil-based lotions or salves.
- Do not lubricate fittings, connections, tubing, or other accessories of the oxygen concentrator to avoid the risk of fire and burns.
- Geriatric or any other patient unable to communicate discomfort, or hear or see the alarms while using this device, may require additional monitoring.
- Use only power cords supplied by Philips Respironics for this device. Use of power cords not supplied by Philips Respironics may cause overheating or damage to the device and may result in increased emissions or decreased immunity of the equipment or system.
- The use of incompatible parts or accessories can result in degraded performance.

Cautions

A caution represents the possibility of damage to the equipment.

- Do not place liquids on or near the device.
- If liquid is spilled on the device, turn the power off and unplug from electrical outlet before attempting to clean up spill. Call your home care provider if device does not continue to work properly.

Chapter 2: Operating Instructions

Warning: Do not use extension cords or electrical adapters.

1. Select a location that allows the concentrator to draw in room air without being restricted. Make sure that the device is at least 15 to 30 cm away from walls, furniture, and especially curtains that could impede adequate airflow to the device. Do not place the device near any heat source.
2. After reading this entire manual, plug the power cord into an electrical outlet. Before plugging the unit into a wall outlet (AC power):
 - Verify that the AC power cord is labeled with 120 VAC or 230 VAC.
 - Verify that the AC power in the wall outlet matches the voltage that is labeled on the AC power cord.
 - If the AC power in the wall outlet matches the voltage labeled on the AC power cord, plug the device into the AC wall outlet.
 - If the AC power in the wall outlet does not match the voltage labeled on the AC power cord, do not plug the device into the AC wall outlet. Contact your health care professional for assistance.

Oxygen Outlet Port

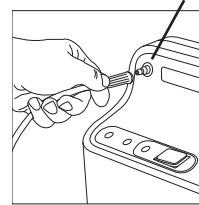

Step 3-A

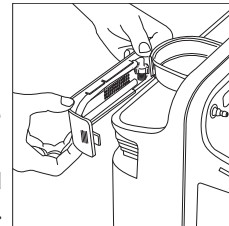

Step 3-B1

3. Do either Step A or Step B below.
 - A. If you are not using a humidifier, connect your nasal cannula to the Oxygen Outlet Port, as shown in the top illustration on the right.
 - B. If you are using a humidifier, follow the steps below:
 1. Open the filter door on the back of the device as shown.
 2. Remove the humidifier connector tube from the back of the filter door and replace the filter door, as shown.
 3. Fill your humidifier bottle according to the manufacturer's instructions.
 4. Mount the filled humidifier on the top of the EverFlo / EverFlo Q device inside the Velcro strap, as shown in the illustration on the right.
 5. Tighten the Velcro strap around the bottle and secure it so it is held firmly in place.
 6. Connect the humidifier connector tube (that you retrieved from the filter door) to the Oxygen Outlet Port (as shown in Step 3-A above).
 7. Connect the other end of the humidifier connector tube to the top of the humidifier with the elbow in the tubing facing the front, as shown here.
 8. Connect your cannula to the humidifier bottle according to the humidifier bottle manufacturer's specifications.

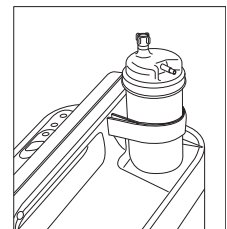

Step 3-B4

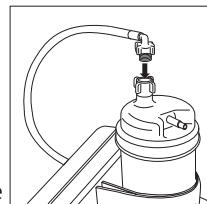

Step 3-B7

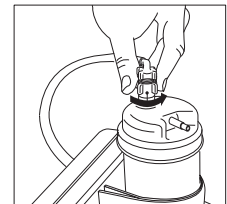

4. Press the power switch to the On [I] position. Initially, all the LEDs will illuminate and the audible alert will beep for a few seconds. Only the green LED should remain lit.

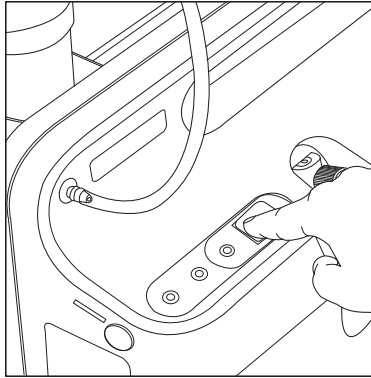

Note: If the device is stored at the minimum storage temperature between uses, please allow 2.5 hours for the unit to adequately warm up.

Note: If the device is stored at the maximum storage temperature between uses, please allow 2.5 hours for the unit to adequately cool down.

5. After turning on the Oxygen Concentrator, you can begin breathing from the device immediately; however, allow at least 10 minutes for oxygen delivery to reach defined specifications.
6. Adjust the flow to the prescribed setting by turning the knob on the top of the flow meter until the ball is centered on the line marking the specific flow rate.

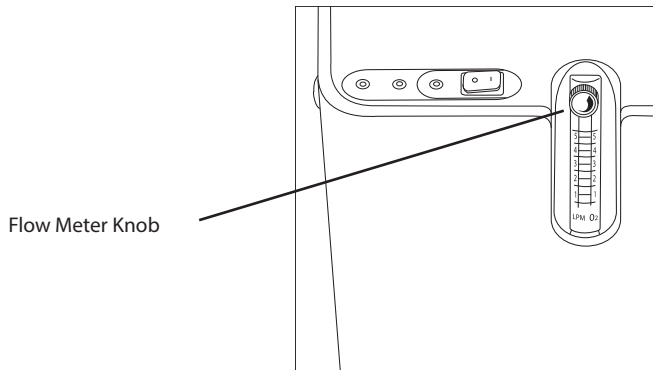

7. Be sure oxygen is flowing through the cannula. If it is not, refer to the Troubleshooting Guide in this manual.

- Put on the cannula as directed by your home care provider.
- When you are not using the oxygen concentrator, press the power switch to the Off [O] position.

Chapter 3: Cleaning, Disinfecting, and Maintenance

Cleaning and Disinfecting the Device

Warning: *It is important to unplug the device before you perform any cleaning and disinfecting.*

Warning: *Do not remove the covers of this device. Servicing must be referred to an authorized and trained Philips Respironics home care provider.*

Caution: *Excess moisture may impair the proper operation of the device.*

Cleaning

The exterior covers of the device should be cleaned weekly and between patient use and as needed by performing the following steps:

- Turn the device off and disconnect from the power source before cleaning.
- Clean the device exterior, including the filter door, using a damp cloth with a mild household cleaner and wipe it dry.

Disinfection

The exterior covers of the device should be disinfected between patient use as follows:

- Clean the device as indicated above.
- To disinfect, use a household chlorine bleach containing 8.25% sodium hypochlorite. Combine 10 parts water to 1 part bleach.
- Using a damp cloth with the bleach solution, wipe the exterior surfaces.
- Allow the surface to remain damp for 2 minutes. Wipe dry as necessary.

Humidifier, Cannula and Tubing

Clean and replace the humidifier, cannula and tubing as instructed by the manufacturer and your equipment provider.

Filters

The EverFlo air inlet filter should be routinely replaced by the provider as deemed necessary.

Service

The EverFlo / EverFlo Q Oxygen Concentrator contains no user-serviceable parts.

Chapter 4: Alarms and Troubleshooting

Alarm and Indicators

The device has an audible alarm and three LED indicators, as shown below.

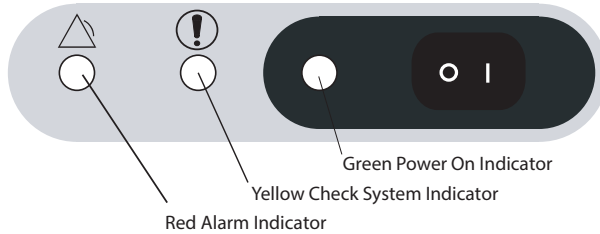

Note: All EverFlo alarms are low priority alarms. The alarm system should be verified before use and between users by service personnel in accordance with the EverFlo service manual.

Audible Alarm / Colored LED	Possible Cause	Your Action
All 3 LEDs illuminate continuously and the Audible Alarm is sounding continuously.	The device has detected a system malfunction.	Immediately turn off the device, connect to a back up oxygen source, and call your home care provider.
The Audible Alarm is sounding continuously. None of the LEDs are illuminated.	The device is turned on but is not operating. Often this indicates that the device is not plugged in or there is a power failure.	Check the power outlet and verify that the device is plugged in. If the problem continues, connect to a back up oxygen source and call your home care provider.
Red LED illuminates continuously and the Audible Alarm is sounding continuously.	The device has detected a system malfunction.	Immediately turn off the device and wait 5 minutes. Restart the device. If the condition persists turn the unit off, connect to a back up oxygen source, and call your home care provider.

<p>Yellow LED illuminates continuously. The Red LED is blinking and the Audible Alarm is beeping periodically.</p>	<p>The device has detected an impeded oxygen flow condition.</p>	<p>Follow the troubleshooting guide on the next page. Connect to a back up oxygen source and call your home care provider if your troubleshooting actions fail to end this alert condition. Note: The No Oxygen Flow alarm may take up to 1.5 minutes to activate from the time the alarm condition is present.</p>
<p>Yellow LED is blinking. The Red LED is not illuminated and the Audible Alarm is beeping periodically.</p>	<p>The device has detected a high oxygen flow condition.</p>	<p>Follow the troubleshooting guide on the next page. Connect to a backup oxygen source, and call your home care provider if your troubleshooting actions fail to end this alert condition. Note: The High Oxygen Flow alarm may take up to 1 minute to activate from the time the alarm condition is present.</p>
<p>Yellow LED illuminates continuously. The Red LED is off and the Audible Alarm is silent.</p>	<p>The device has detected a low oxygen condition (OPI units only).</p>	<p>Continue using the unit but call your home care provider about this condition. Note: The Low Oxygen alarm may take up to 15 minutes to activate from the time the alarm condition is present.</p>

Troubleshooting Guide

The table below lists common problems and actions you can take. If you are unable to resolve a problem, please contact your equipment provider.

Problem	Why it Happened	What to Do
High oxygen flow indication is activated. (Yellow LED is blinking. The Red LED is off and the Audible Alarm is beeping periodically.)	The device has detected a high oxygen flow condition.	Turn the flow rate down to your prescribed level. Wait at least 2 minutes. If the condition persists turn the unit off, connect to a back up oxygen source, and call your home care provider.
Green LED illuminates continuously. The other LEDs are off and the Audible Alarm is silent.	The device is turned on and working properly.	Take no action.
The device is not working when it is turned on. (The Audible Alarm is sounding continuously. All LEDs are off.)	The power cord plug is not properly inserted into the electrical outlet.	Make sure the device is properly plugged in to the electrical outlet.
	The unit is not receiving power from the electrical outlet.	Check your household outlet fuse or circuit.
	Internal part failure.	Connect to a back up oxygen source and contact your home care provider.
The device is not working when it is turned on. (The Audible Alarm is sounding continuously and all 3 LEDs are illuminated.)	Internal part failure.	Connect to a back up oxygen source and contact your home care provider.
Impeded oxygen flow indication is activated. (The Yellow LED illuminates continuously, the Red LED is blinking, and the Audible Alarm is beeping periodically.)	The flow meter knob is completely closed.	Turn the flow meter knob counterclockwise to center the ball on the prescribed LPM flow.
	The oxygen tubing is kinked and blocking the delivery of oxygen.	Check to see that the tubing is not kinked or blocked. Replace if necessary.
Limited oxygen flow to the user without any fault indication. (All LEDs are off and the Audible Alarm is silent.)	The oxygen tubing or cannula is faulty.	Inspect and replace the items if necessary.
	There is a poor connection to a device accessory.	Ensure that all connections are free from leaks.

Chapter 5: Specifications

Environmental

	Operating	Transport & Storage
Temperature	13 to 32° C	-34 to 71° C
Relative Humidity	15 to 95%, noncondensing	15 to 95%, noncondensing
Altitude	0 to 2286 m.	N/A

Physical

Dimensions	58 cm x 38 cm x 24 cm
Weight	14 to 15 kg
Expected Service Life of Device and Accessories	5 years
Maximum Outlet Pressure	6.5 PSIG (44.8 kPa)
Sound Level	Device: 50 dBA or less Alarm: 60 dBA or greater
Operating Pressure	69.7 kPa to 101 kPa

Standards Compliance

This device is designed to conform to the following standards:

- IEC 60601-1 Medical Electrical Equipment, Part 1: General requirements for basic safety and essential performance
- IEC 60601-1-2 Medical Electrical Equipment, Part 1-2: General Requirement for Safety - Collateral Standard: Electromagnetic Compatibility - Requirements and Tests
- IEC 60601-1-6 Medical electrical equipment - Part 1-6: General Requirements for Basic Safety and Essential Performance - Collateral Standard: Usability
- IEC 60601-1-8 Medical electrical equipment – Part 1-8: General Requirements for Basic Safety and Essential Performance – Collateral Standard: General requirements, tests, and guidance for alarm systems in medical electrical equipment and medical electrical systems
- IEC 60601-1-11 Medical electrical equipment – Part 1-11: General Requirements for Basic Safety and Essential Performance – Collateral Standard: Requirements for medical electrical equipment and medical electrical systems used in the home healthcare environment
- ISO 80601-2-69, Medical Electrical Equipment, Part 2-69: Particular Requirements for Basic Safety and Essential Performance of Oxygen Concentrator Equipment
- ISO 8359 Oxygen Concentrators for Medical Use - Safety Requirements
- IEC 62366-1 Medical devices - Part 1: Application of usability engineering to medical devices
- ISO 10993-1, Biological Evaluation of Medical Devices, Part 1: Evaluation and Testing (Biocompatibility)

NOTE: The EverFlo has Essential Performance as defined in ISO 80601-2-69. The EverFlo will deliver oxygen in both normal and single fault conditions per the specifications in this manual, or in the case of a power supply failure, low oxygen concentration, or device malfunction, an alarm condition will occur.

Electrical, AC Power Consumption

<p>Models 1020000, 1020001 1020002, 1020003 1020002BR, 1020003BR 1020014, 1020015 1039362, 1039363 1039364, 1039365</p>	<p>120 VAC ±10%, 350 W, 60 Hz</p>
<p>1020004, 1020005</p>	<p>220 VAC ±10%, 320 W, 60 Hz</p>
<p>1020006, 1020007, 1020008 1020009, 1020010, 1020011 1020012, 1020016, 1020017 1020020, 1039366, 1039367 1039368, 1039370, 1104000, 1125558</p>	<p>230 VAC ±10%, <300 W, 50 Hz</p>
<p>1102443</p>	<p>230 VAC ±10%, <300 W, 60 Hz</p>
<p>1020013</p>	<p>220 VAC ±10%, <300W, 60 Hz</p>

Oxygen

<p>Oxygen Concentration* (All Models except as noted below)</p>	<p>90-96% from 1 to 5 LPM**</p>
<p>Models 1020007, 1020008, 1039367, 1039368, 1104000</p>	<p>87-96% from 1 to 5 LPM**</p>

* Device operation above or outside of the voltage, LPM, temperature, humidity and/or altitude values specified may decrease oxygen concentration levels.

** Oxygen flow rate <1 LPM requires low range flow meter accessory.

Maximum output pressure limited to 6.5 PSIG (44.8 kPa).

Sound Level

Models	Sound Level (when measured at 1m from front of device)
1020000, 1020001 1020002, 1020003 1020004, 1020005, 1039362, 1039363	45 dBA typical
102002BR, 102003BR 1020006, 1020008 1020009, 1020010 1020011, 1020012 1020013, 1020016, 1020017, 1020020 1039366, 1039364 1039365, 1039368 1039370, 1102443 1104000	43 dBA typical
1020007, 1020014 1020015, 1039367, 1125558	<40 dBA typical

Note: Maximum Sound Pressure Level is 51 dB(A) and Maximum Sound Power is 59 dB(A) at 3LPM and 5LPM with an uncertainty of 2dB(A). Measured according to noise test method given in ISO 80601-2-69:2014 using the basic standards ISO 3744 and ISO 4871.

Disposal

Separate collection for electrical and electronic equipment per EC Directive 2012/19/EU. Dispose of this device in accordance with local regulations.

Appendix A: EMC Information

GUIDANCE AND MANUFACTURER’S DECLARATION - ELECTROMAGNETIC EMISSIONS: This device is intended for use in the electromagnetic environment specified below. The user of this device should make sure it is used in such an environment.

EMISSIONS TEST	COMPLIANCE	ELECTROMAGNETIC ENVIRONMENT - GUIDANCE
RF emissions CISPR 11	Group 1	The device uses RF energy only for its internal function. Therefore, its RF emissions are very low and are not likely to cause any interference in nearby electronic equipment.
RF emissions CISPR 11	Class B	
Harmonic emissions IEC 61000-3-2	Class A	
Voltage fluctuations/Flicker emissions IEC 61000-3-3	Complies	

GUIDANCE AND MANUFACTURER’S DECLARATION - ELECTROMAGNETIC IMMUNITY: This device is intended for use in the electromagnetic environment specified below. The user of this device should assure that it is used in such an environment.

IMMUNITY TEST	IEC 60601 TEST LEVEL	COMPLIANCE LEVEL	ELECTROMAGNETIC ENVIRONMENT - GUIDANCE
Electrostatic Discharge (ESD) IEC 61000-4-2	±6 kV contact ±8 kV air	±6 kV contact ±8 kV air	Floors should be wood, concrete or ceramic tile. If floors are covered with synthetic material, the relative humidity should be at least 30%.
Electrical Fast Transient/Burst IEC 61000-4-4	±2 kV for power supply lines ±1 kV for input-output lines	±2 kV for Power Supply Lines NA - Device does not have user I/O lines that are longer than 3m in length.	Mains power quality should be that of a typical home or hospital environment.
Surge IEC 61000-4-5	±1 kV Line to Line ±2 kV Line to Ground	±1 kV Line to Line NA - The device is a Class II device and does not connect to earth ground.	Mains power quality should be that of a typical home or hospital environment.
Voltage dips, short interruptions and voltage variations on power supply input lines IEC 61000-4-11	<5% U_T (>95% dip in U_T) for 0.5 cycle 40% U_T (60% dip in U_T) for 5 cycles 70% U_T (30% dip in U_T) for 25 cycles <5% U_T (>95% dip in U_T) for 5 sec	<5% U_T (>95% dip in U_T) for 0.5 cycle 40% U_T (60% dip in U_T) for 5 cycles 70% U_T (30% dip in U_T) for 25 cycles <5% U_T (>95% dip in U_T) for 5 sec	Mains power quality should be that of a typical home or hospital environment. If the user of the device required continued operation during power mains interruptions, it is recommended that the device be powered from an uninterruptible power supply or a battery.
Power frequency (50/60 Hz) magnetic field IEC 61000-4-8	3 A/m	3 A/m	Power frequency magnetic fields should be at levels characteristic of a typical location in a typical home or hospital environment.
Note: U_T is the a.c. mains voltage prior to application of the test level.			

GUIDANCE AND MANUFACTURER’S DECLARATION - ELECTROMAGNETIC IMMUNITY: This device is intended for use in the electromagnetic environment specified below. The user of this device should assure that it is used in such an environment.

IMMUNITY TEST	IEC 60601 TEST LEVEL	COMPLIANCE LEVEL	ELECTROMAGNETIC ENVIRONMENT - GUIDANCE
Conducted RF IEC 61000-4-6	3 Vrms 150 kHz to 80 MHz	3 Vrms	Portable and mobile RF communications equipment should be used no closer to any part of the device, including cables, than the recommended separation distance calculated from the equation applicable to the frequency of the transmitter. Recommended separation distance: $d = 1.2 \sqrt{P}$ $d = 1.2 \sqrt{P}$ 80 MHz to 800 MHz $d = 2.3 \sqrt{P}$ 800 MHz to 2.5 GHz Where P is the maximum output power rating of the transmitter in watts (W) according to the transmitter manufacturer and d is the recommended separation distance in meters (m). Field strengths from fixed RF transmitters, as determined by an electromagnetic site survey ^a , should be less than the compliance level in each frequency range ^b . Interference may occur in the vicinity of equipment marked with the following symbol: 
Radiated RF IEC 61000-4-3	3 V/m 80 MHz to 2.5 GHz	3 V/m	

Note 1: At 80 MHz and 800 MHz, the higher frequency range applies.

Note 2: These guidelines may not apply in all situations. Electromagnetic propagation is affected by absorption and reflection from structures, objects, and people.

a: Field strength from fixed transmitters such as base stations for radio (cellular/cordless) telephones and land mobile radios, amateur radio, AM and FM radio broadcast and TV broadcast cannot be predicted theoretically with accuracy. To assess the electromagnetic environment due to fixed RF transmitters, an electromagnetic site survey should be considered. If the measured field strength in the location in which the Device is used exceeds the applicable RF compliance level above, the Device should be observed to verify normal operation. If abnormal performance is observed, additional measures may be necessary, such as re-orienting or relocating the Device.

b: Over the frequency range 150 kHz to 80 MHz, the field strengths should be less than 3 V/m.

RECOMMENDED SEPARATION DISTANCES BETWEEN PORTABLE AND MOBILE RF COMMUNICATIONS EQUIPMENT AND THE DEVICE: The Device is intended for use in the electromagnetic environment in which radiated RF disturbances are controlled.

The user of the Device can help prevent electromagnetic interference by maintaining a minimum distance between portable and mobile RF communication equipment (transmitters) and the Device as recommended below, according to the maximum output power of the communications equipment.

RATED MAXIMUM OUTPUT POWER OF TRANSMITTER (WATTS)	SEPARATION DISTANCE ACCORDING TO FREQUENCY OF TRANSMITTER (METERS)		
	150 kHz to 80 MHz $d = 1.2 \sqrt{P}$	80 MHz to 800 MHz $d = 1.2 \sqrt{P}$	800 MHz to 2.5 GHz $d = 2.3 \sqrt{P}$
0.01	0.12	0.12	0.23
0.1	0.38	0.38	0.73
1	1.2	1.2	2.3
10	3.8	3.8	7.27
100	12	12	23

For transmitters rated at a maximum output power not listed above, the recommended separation distance d in meters (m) can be estimated using the equation applicable to the frequency of the transmitter, where P is the maximum output power rating of the transmitter in watts (W) according to the transmitter manufacturer.

Note 1: At 80 MHz and 800 MHz, the separation distance for the higher frequency range applies.

Note 2: These guidelines may not apply in all situations. Electromagnetic propagation is affected by absorption and reflection from structures, objects, and people.

Limited Warranty

Respironics, Inc. warrants that the system shall be free from defects of workmanship and materials and will perform in accordance with the product specifications for a period of three (3) years from the date of sale by Respironics, Inc. to the dealer. Respironics warrants that the EverFlo / EverFlo Q units serviced by Respironics, or an authorized service center, will be free from defects in serviced materials for a period of 90 days and free from defects in workmanship for a period of 90 days from the time of service. Respironics accessories are warranted to be free of defects in materials and workmanship for a period of 90 days from the time of purchase. If the product fails to perform in accordance with the product specifications, Respironics, Inc. will repair or replace – at its option – the defective material or part. Respironics, Inc. will pay customary freight charges from Respironics, Inc. to the dealer location only. This warranty does not cover damage caused by accident, misuse, abuse, alteration, and other defects not related to material or workmanship.

Respironics, Inc. disclaims all liability for economic loss, loss of profits, overhead, or consequential damages which may be claimed to arise from any sale or use of this product. Some states do not allow the exclusion or limitation of incidental or consequential damages, so the above limitation or exclusion may not apply to you.

This warranty is given in lieu of all other express or implied warranties, including the implied warranties of merchantability and fitness for a particular purpose. In addition, in no event shall Respironics be liable for lost profits, loss of good will, or incidental or consequential damages, even if Respironics has been advised of the possibility of the same. Some states or provinces do not allow the exclusion of limitation of implied warranties or the disclaimer of incidental and consequential damages. Accordingly, the laws of your state or province may give you additional protections.

To exercise your rights under this warranty, contact your local authorized Respironics, Inc. dealer or contact Respironics, Inc. at:

Respironics Inc.
1001 Murry Ridge Lane
Murrysville, PA 15668 USA



1-724-387-4000

Respironics Deutschland GmbH & Co. KG
Gewerbestr. 17
82211 Herrsching, Germany



+49 8152 93060

Note: For Australian and New Zealand customers this warranty replaces the warranty contained above.

Respironics, Inc., a Philips Healthcare company warrants that the Products shall be free from defects of workmanship and materials and will perform in accordance with the Product specifications. 2. This warranty is valid for a period of three (3) years from the date of purchase from an authorised Respironics dealer. 3 If the Product is found to contain a defect of workmanship or materials or fails to perform in accordance with the Product specifications during the applicable warranty period, Respironics will repair or replace, at its option, the defective material or part. 4. The customer is responsible for returning the product to an authorised Philips Respironics dealer, and collecting the product from the authorised Philips Respironics dealer after repair or replacement, at its own cost. Philips Respironics is responsible only for the freight cost of transporting the product between the authorised Philips Respironics dealer and Respironics. Respironics reserves the right to charge an evaluation and postage fee for any returned Product as to which no problem is found following investigation. 5. This warranty does not cover damage caused by accident, misuse, abuse, alteration, and other defects not related to materials or workmanship. 6. The warranty provided by Respironics herein is not transferrable by the Buyer in the event of any sale or transfer of Products purchased by the Buyer from an authorised Respironics dealer. 7 To the extent permitted by law, where the Buyer has the benefit of an implied guarantee under the Australian Consumer Law, but the Product is not of a kind ordinarily acquired for personal, domestic or household use or consumption Respironics' liability shall be limited, at the option of Respironics, to the replacement or repair of the Product or the supply of an equivalent Product. 8. To exercise your rights under this warranty, contact your local authorised Philips Respironics dealer. A list of all authorised dealers is available at the following link:
http://www.healthcare.philips.com/au_en/homehealth/distributors_index.wpd.

Alternatively, you can make a claim under this warranty by contacting Respironics directly at: Philips Electronics Australia Limited, 65 Epping Road, North Ryde NSW 2113, Australia. Tel: 1300 766 488, Email: prcontact@philips.com. 9. The following statement is provided to a Buyer who is a "consumer" under the Australian Consumer Law: Our goods come with guarantees that cannot be excluded under the Australian Consumer Law. You are entitled to a replacement or refund for a major failure and for compensation for any other reasonably foreseeable loss or damage. You are also entitled to have the good repaired or replaced if the goods fail to be of acceptable quality and the failure does not amount to a major failure. 10. The following statement is provided to a Buyer who is a "consumer" under the Consumer Guarantees Act 1993, New Zealand: Our goods come with guarantees that cannot be excluded under the Consumer Guarantees Act 1993. This guarantee applies in addition to the conditions and guarantees implied by that legislation.